

8 7 6 5 4 3 2 1

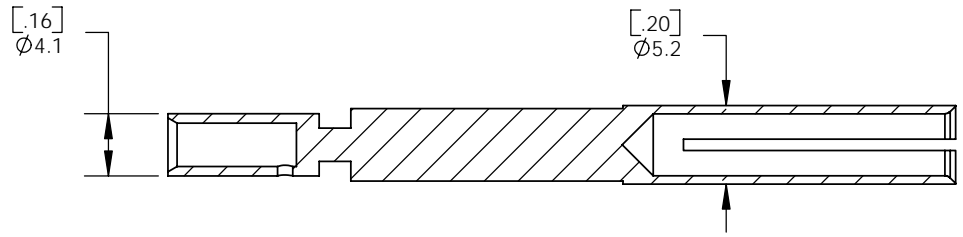

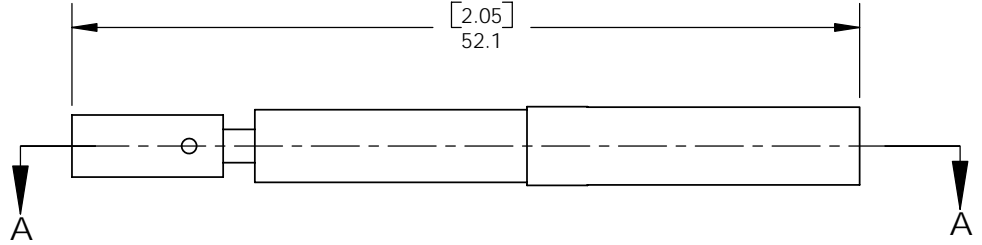
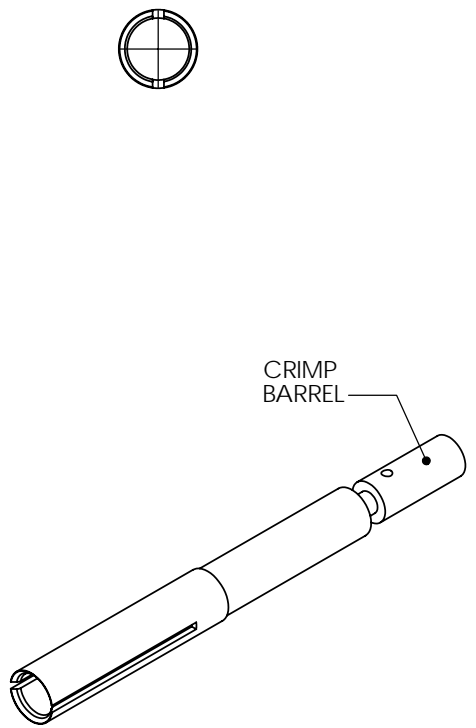

THE INFORMATION CONTAINED IN THIS DRAWING IS THE SOLE PROPERTY OF ANDERSON POWER PRODUCTS. ANY REPRODUCTION IN PART OR WHOLE WITHOUT THE WRITTEN PERMISSION OF ANDERSON POWER PRODUCTS IS PROHIBITED.

Copyright 2005

ANDERSON POWER PRODUCTS RESERVES THE RIGHT TO ALTER PRODUCT TYPES, THEIR TECHNICAL DATA, DIMENSION, STYLE AND ACCESSORIES WITHOUT PRIOR NOTIFICATION.



SECTION A-A

DIMENSIONS ARE IN:		<input checked="" type="checkbox"/> INCH[MM]	MM[INCH]	APPROVALS		 ANDERSON POWER PRODUCTS	
UNLESS OTHERWISE STATED				DRAWN	AMP	5/11/05	TITLE SALES OUTLINE EBC DIN AUX. SOCKET CONTACT CAT. NO. E320-35 (4MM WIRE)
TOLERANCES:				CHECKED	DJD	5/11/05	
DECIMALS (INCH)	DECIMALS (MM)	ANGLES		MFG APP	CHB	5/11/05	
XX ±.02	X ±.5	±2°		QC APP	UFN	5/11/05	
SURFACE FINISH:				ENG APP	DAM	5/11/05	
MACHINED		128 [3.2] ✓		SIZE		A/A4	DWG NO.
MOLDED		64 [1.6] ✓		SCALE		NONE	E320-35 S1
MATERIAL: COPPER ALLOY				REV.		1	
FINISH: SILVER PLATE				-CAD GENERATED DRAWING- DO NOT MANUALLY UPDATE DO NOT SCALE		CADFILE	
  				SHEET		1 OF 1	
1		ECRN 13969 - ADD STEP-DOWN TO SOCKET BODY		AMS		03/03/06	
REV.	DESCRIPTION OF CHANGES			APPROVED	DATE		

1	ECRN 13969 - ADD STEP-DOWN TO SOCKET BODY	AMS	03/03/06
REV.	DESCRIPTION OF CHANGES	APPROVED	DATE

8 7 6 5 4 3 2 1

THE INFORMATION CONTAINED IN THIS DRAWING IS THE SOLE PROPERTY OF ANDERSON POWER PRODUCTS. ANY REPRODUCTION IN PART OR WHOLE WITHOUT THE WRITTEN PERMISSION OF ANDERSON POWER PRODUCTS IS PROHIBITED.

Copyright 2005

ANDERSON POWER PRODUCTS RESERVES THE RIGHT TO ALTER PRODUCT TYPES, THEIR TECHNICAL DATA, DIMENSION, STYLE AND ACCESSORIES WITHOUT PRIOR NOTIFICATION.

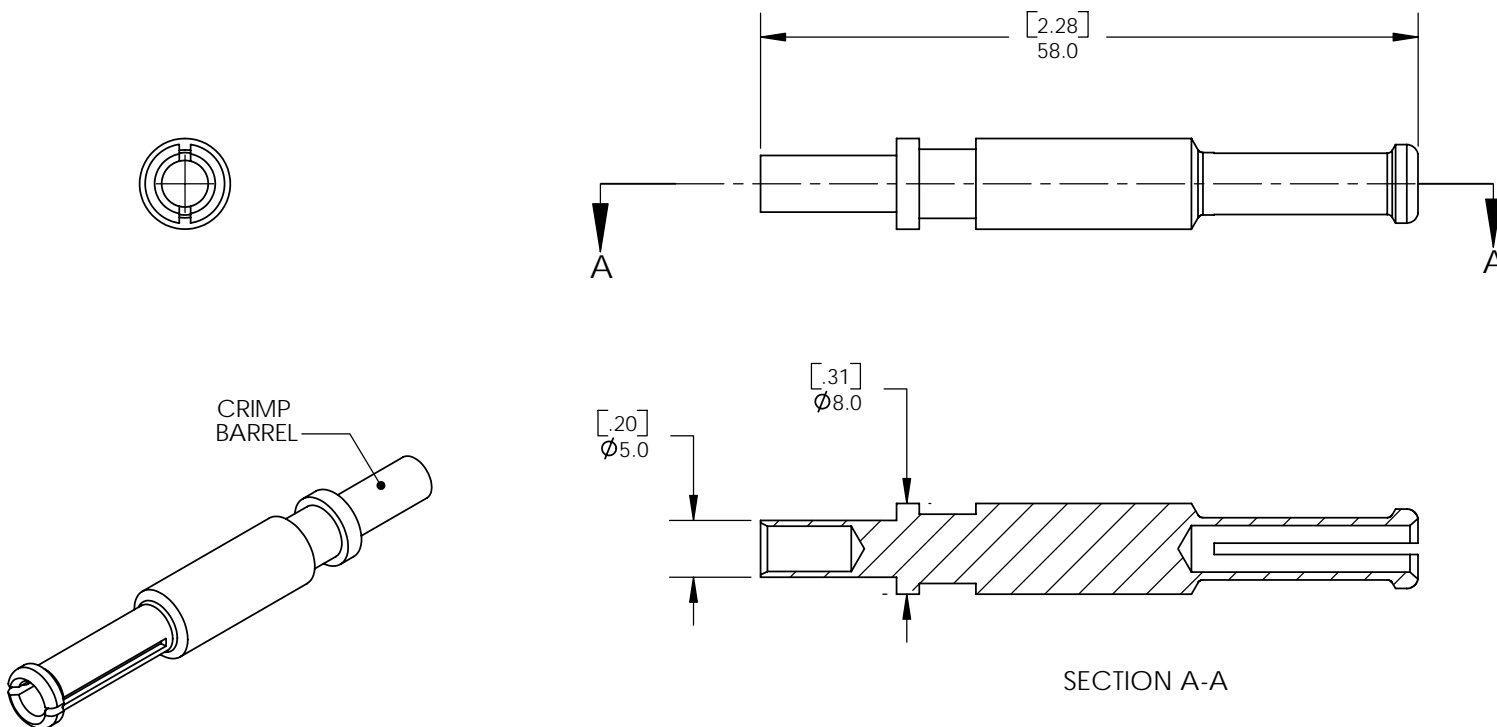

DIMENSIONS ARE IN:		<input checked="" type="checkbox"/> INCH[MM]	<input type="checkbox"/> MM[INCH]	APPROVALS			ANDERSON POWER PRODUCTS		
UNLESS OTHERWISE STATED				DRAWN		TITLE			
TOLERANCES:				AMP		SALES OUTLINE			
DECIMALS (INCH)		DECIMALS (MM)		CHECKED		EBC DIN AUX. SOCKET CONTACT			
XX ± .02		X ± .5		DJD		CAT. NO. E160-31 (6MM WIRE)			
SURFACE FINISH:				MFG APP		REV.			
MACHINED		128 [3.2] ✓		CHB		SIZE		DWG NO.	
MOLDED		64 [1.6] ✓		UFN		A/A4		E160-31 S1	
MATERIAL: COPPER ALLOY				QC APP		SCALE		CADFILE	
FINISH: SILVER PLATE				ENG APP		NONE		02324	
				DAM		SHEET		1 OF 1	
				-CAD GENERATED DRAWING- DO NOT MANUALLY UPDATE DO NOT SCALE					

REV.	DESCRIPTION OF CHANGES	APPROVED	DATE

