

THE INFORMATION CONTAINED IN THIS DRAWING IS THE SOLE PROPERTY OF ANDERSON POWER PRODUCTS. ANY REPRODUCTION IN PART OR WHOLE WITHOUT THE WRITTEN PERMISSION OF ANDERSON POWER PRODUCTS IS PROHIBITED.

BY:	DATE:
REV.	DESCRIPTION OF CHANGES

**3 PRONG PCB CONTACT (TWO REQUIRED):**

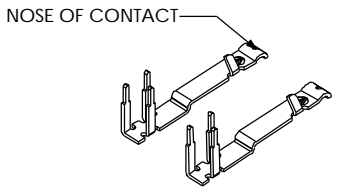

**HOUSING: SB50-SERIES**

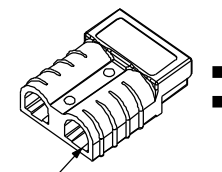

**ASSEMBLED HOUSING AND CONTACTS SB-PCB-SERIES**

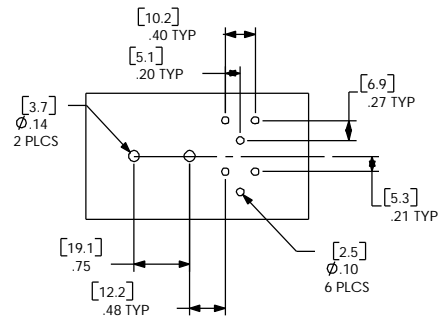
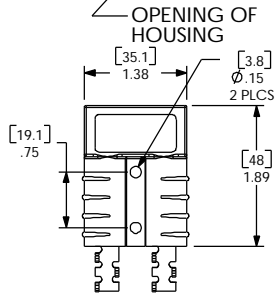
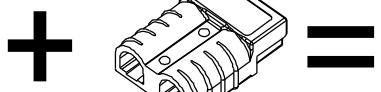
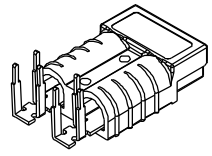

SUGGESTED PC BOARD HOLE LAYOUT

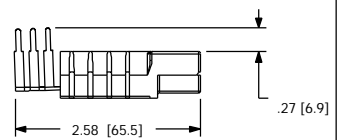
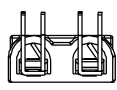

**NOTES:**

- ASSEMBLE PROPER CONTACT INTO REQUIRED HOUSING AS SHOWN, BY INSERTING NOSE OF CONTACT INTO OPENING IN HOUSING. AN AUDIBLE "CLICK" WILL BE HEARD WHEN THE CONTACT ENGAGES THE SPRING OF THE HOUSING. THE COMPLETED ASSEMBLY SHOULD RESULT IN THE DIMENSIONS AS SHOWN IN THE SIDE VIEW.
- INSURE THAT THE LEGS OF THE CONTACT ARE NOT BENT PRIOR TO ENGAGEMENT OR DURING INSERTION INTO HOUSING. IF THIS OCCURS, REMOVE THE CONTACT FROM THE HOUSING, DISCARD, AND INSERT A NEW CONTACT INTO THE HOUSING USING NOTE 1 AS AN INSTALLATION GUIDE.
- WHEN ASSEMBLED, THE BACK SURFACE OF THE CONTACT SHOULD BE JUST TOUCHING THE EDGE OF THE HOUSING OPENING.

ITEM NO.	PART OR IDENTIFYING NO.	NOMENCLATURE OR DESCRIPTION	MATERIAL SPECIFICATION	QTY REQD
COPYRIGHT 1999 ANDERSON POWER PRODUCTS. ALL RIGHTS RESERVED. UNAUTHORIZED REPRODUCTION HEREBY PROHIBITED.				
DIMENSIONS ARE IN INCHES DIMENSIONS IN PARENTHESES [ ] ARE IN MILLIMETERS		CAD GENERATED DRAWING, DO NOT MANUALLY UPDATE		<b>ANDERSON POWER PRODUCTS</b>
TOLERANCES ARE: 2PL- ±.02 [±.5]		APPROVALS	DATE	
MATERIALS:	N/A	DRAWN	CGC 8/10/98	<b>SB50-SERIES HOUSING &amp; 3 PRONG PCB CONTACT ASSEMBLY</b>
FINISH	N/A	CHECKED	DJD 10/6/99	
NEXT ASSY	USED ON	RESP ENG	UFN 10/6/99	
APPLICATION	DO NOT SCALE DRAWING	MFG ENG	CHB 10/7/99	
		QUAL ENG	RPO 10/7/99	SIZE A SPECIFICATION: 114197S1 REV. 0
			SCALE NONE CADFILES/01121	SHEET 1 OF 1